

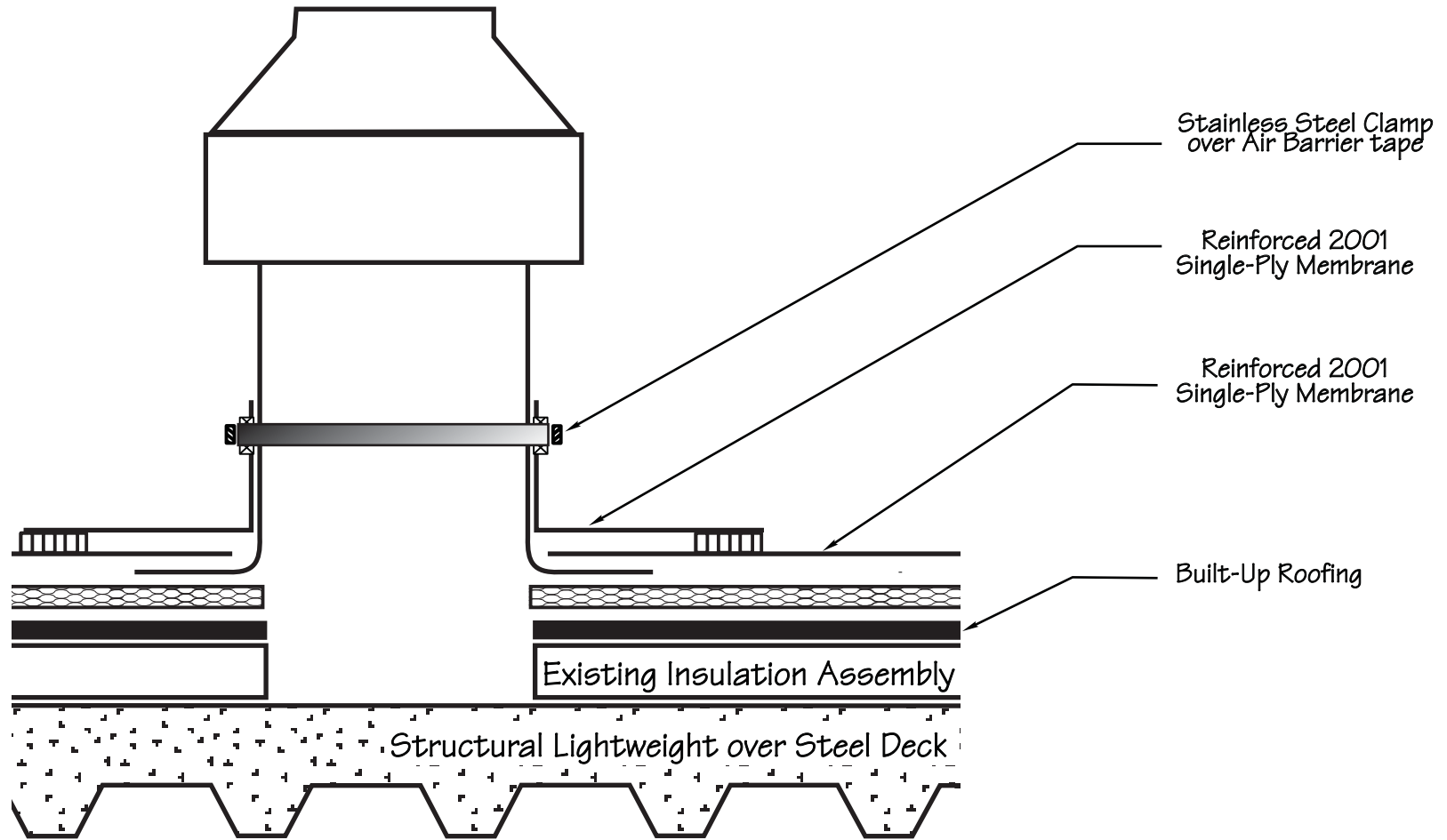









# Equalizer Valve Detail



 Bead of Caulk	 Air Barrier Tape	 Foam	Project name	
 Reinforced Polyethylene Separator Sheet	 Hot Air Weld	 Fireguard Mat	Manatee EOC	
 Bonding Adhesive	 Insulation		Drawn by:	MDJ
 Water Cut-off Mastic	 Air Seal Rope		Scale:	NTS
			Drawing Number:	#6
			<b>2001 COMPANY</b> 325 Thomaston Ave. P.O. Box 2557 Waterbury, CT 06723 800-537-7663	